

Keeler Digital Applanation Tonometer (D-KAT) Z-type

Instructions for use

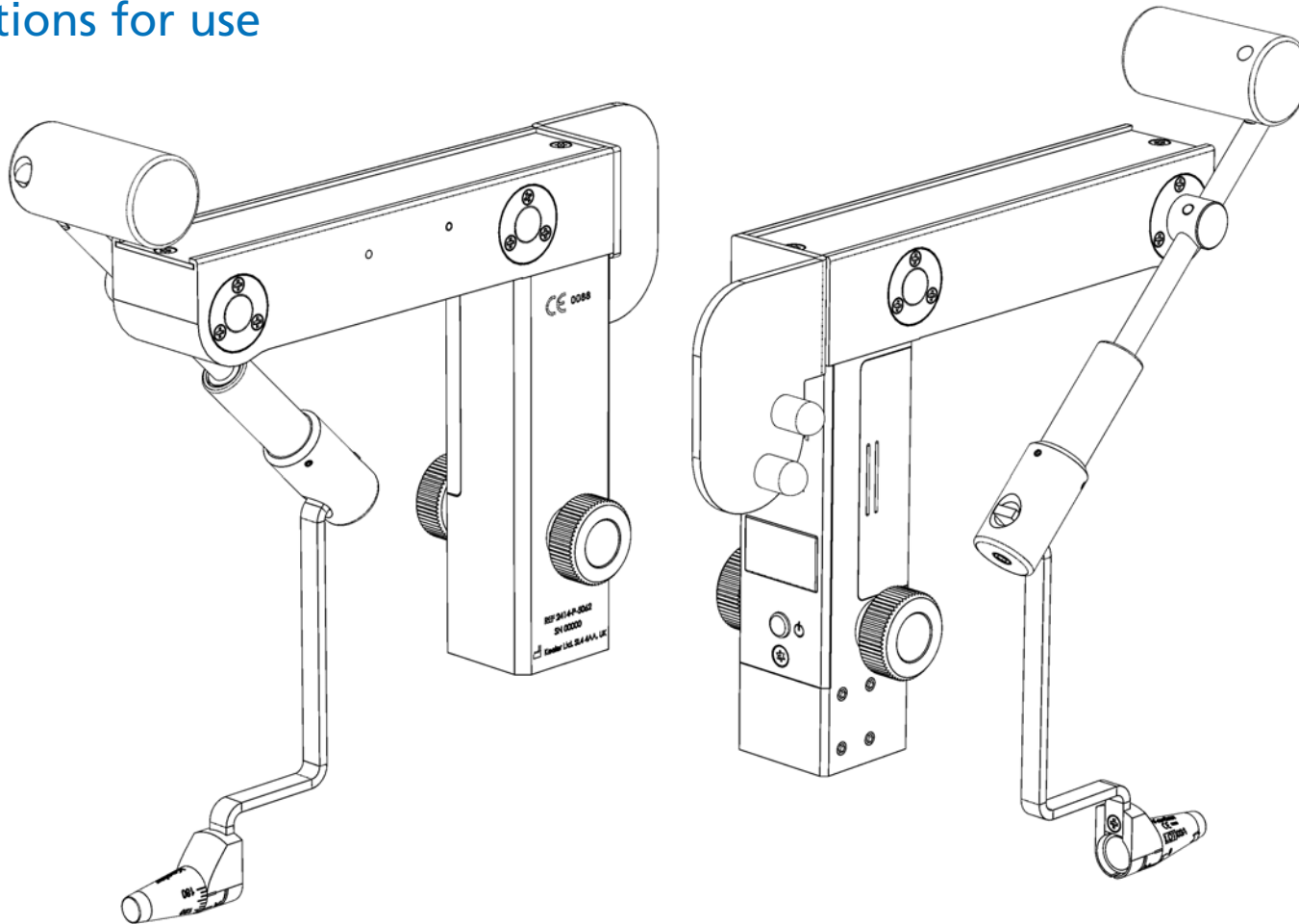

Keeler

Next ▶

Contents

- 1. Introduction**
 - 1.1 Brief description of the instrument
 - 1.2 Intended use / purpose of instrument
 - 1.3 How the intraocular pressure (IOP) is measured
 - 1.4 Advantages of using a Goldmann type Tonometer
- 2. Symbols used**
- 3. Safety**
 - 3.1 Standards applied
 - 3.2 Warnings and cautions
- 4. Cleaning and disinfection instruction**
 - 4.1 Cleaning Tonometer body
 - 4.2 Disinfecting the Tonometer prisms
- 5. Tonometer Prism field check**
- 6. Name of components**
- 7. Switching on / off and configuring the D-KAT**
 - 7.1 Switching on / off
 - 7.2 Changing decimal point setting
 - 7.3 Changing the display brightness
 - 7.4 Battery status
- 8. Measurement procedure**
 - 8.1 Installation on to the Slit Lamp
 - 8.2 Preparing the patient
 - 8.3 Preparing the Slit Lamp instrument for examinations at 10x magnification
 - 8.4 Using the instrument / taking a measurement
 - 8.4.1 Instructions to the patient
 - 8.4.2 Taking the measurement
- 9. Problem solving**
- 10. General information and suggestions concerning measurement**
- 11. Astigmatism**
- 12. Routine instrument maintenance**
 - 12.1 Check procedure with test arm set to 20
 - 12.2 Check procedure with test arm set to 60
- 13. Servicing and calibration**
 - 13.1 Battery replacement
- 14. Specifications**
 - 14.1 Transport, storage and working conditions
 - 14.2 Technical specifications
- 15. Accessories and warranty**
- 16. Contact information**

Please click on the contents to go straight to your chosen section or navigate by using the 'Next' and 'Back' buttons to the right. Clicking on 'Home' will bring you back to this page.

Keeler

1. Introduction

Thank you for choosing this Keeler Digital Applanation Tonometer (D-KAT).

 Please read this manual carefully before using your D-KAT. This will ensure the safety of the patient and your confidence in the measurements it provides. This manual should be stored safely for future use.

1.1 Brief description of the instrument



The Keeler Applanation Tonometer operates according to the “Goldmann method”, by measuring intraocular pressure from the force required to flatten (applanate) a constant area (3.06mm) of the cornea. A special disinfected (or single use) prism is mounted on the Tonometer head and then placed against the cornea.

The examiner, using a slit lamp biomicroscope at 10x magnification, with a blue filter views two fluorescing green semicircles. The force applied to the Tonometer head is then adjusted using the dial until the inner edges of these green semicircles meet.

Because physical contact with the cornea takes place it is necessary to apply to the patients cornea a suitable topical anaesthetic.

1.2 Intended use / purpose of instrument

The Keeler Digital Applanation Tonometer is indicated for measuring intraocular pressure to aid in the screening and diagnosis of glaucoma.

  Federal law restricts this instrument to sale by or on the order of a physician or practitioner.

The Keeler Digital Applanation Tonometer (D-KAT) is an accessory item for most ‘Zeiss illumination’ type of Slit Lamps and thanks to its versatility, the D-KAT Tonometer can be mounted on and used with slit lamps produced by many manufacturers.

The manufacturer declines any and all responsibility and warranty coverage should the instrument be tampered with in any manner or should routine maintenance be omitted or performed in manners not in accordance with these manufacturer’s instructions.

Keeler

1. Introduction

1.3 How the intraocular pressure (IOP) is measured

The cornea is flattened by an acrylic measuring prism on a ring support at the end of the Tonometer sensor arm assembly. It is flat with smooth or rounded margins to avoid any damage to the cornea.

The measuring prism is brought into contact with the patient's eye by moving the slit lamp forward. The measurement drum is then turned to increase the pressure on the eye until a continuous, uniform applanated surface 3.06 mm in diameter (7,354 mm² area) is obtained. The doubling prism divides the image and presents the two opposing semicircular halves at 3.06mm (see section 7.4.2 Measurement procedure for further details).

LED Display mmHg	Force mN	Pressure kPa
10	9.81	1.33
20	19.62	2.66
30	29.43	3.99
40	39.24	5.32
50	49.05	6.65
60	58.86	7.98

Relationship between the LED display and the force and pressure on the applanated surface.

1.4 Advantages of using a Goldmann Type Tonometer

- Intraocular pressure can be measured during a routine examination with the Slit Lamp.
- The standard deviation among single measurements is approximately $\leq 0,5$ mmHg*.
- The value is expressed in mmHg and is read directly on the instrument.
- Scleral rigidity need not be taken into consideration because the small volume moved (0,56 mm³) increases intraocular pressure by only about 2.5%.

**Please Note: Whilst the D-KAT has a Digital read-out that can indicate decimal point measurement, it is not intended to imply higher accuracy. The D-KAT instrument has been validated to a measurement deviation of ± 0.49 mN (~ 0.5 mmHg) or 1.5%, whichever is greater, in accordance with ISO 8612.*

2. Symbols used



Manufacturers name and address



Mandatory action sign



Power / function button



General warning sign



Type B Applied Part



Non-ionizing radiation



Battery orientation



Serial Number



The CE mark on this product indicates it has been tested to and conforms with the provisions noted within the 93/42/EEC



This way up



Material suitable for recycling



Fragile



This symbol on the Product or on its Packaging and instructions indicates it was put on the market place after August 2005 and this product shall not be treated as Household Waste



Keep dry

3. Safety



Use this instrument only in strict accordance with the instructions contained in this manual.

3.1 Standards applied

The Keeler Applanation Tonometer is designated as Class I non-invasive measuring device under EC Directive 93/42 EEC for medical equipment products.

The CE mark on this product indicates it has been tested to and conforms to the provisions noted within the 93/42 EEC Medical Device Directive.

It also complies with the Ophthalmic Instruments Standard, ISO 8612. Tonometer and ISO 15004-1 fundamental requirements and methods.

Classification

CE Directive 93/42 EEC: Class IIa

FDA: Class II

Continued

Keeler

3. Safety



3.2 Warnings and Cautions

Observe the following precautions in order to ensure safe operation of the instrument.

- This device is intended to be used only by suitably trained and authorised healthcare professionals.
- US Federal Law restricts this device to sale by or on the order of a physician or practitioner.
- Accuracy of applanation IOP measurements is known to be affected by variations and changes in corneal rigidity due to differences in corneal thickness, intrinsic structural factors or corneal refractive surgery. It is recommended that these factors are considered during IOP measurement.
- Never use the instrument if visibly damaged. Periodically inspect it for signs of damage or misuse.
- The contact surface of the prism should be checked before each use for damage and discarded if damage is found.
- Check your Keeler product for signs of transport / storage damage prior to use.
- We recommend that the prism is not used when it becomes more than two years of age as, after this time it is possible that body or sterilising fluids may seep inside leading to possible sterility and cross contamination issues.
- Only decontaminate / clean in accordance with a method given in Cleaning (Section 4) of this instruction manual.
- Use only cloths dampened with water to clean the Applanation Tonometer body. Do not use corrosive products or alcohol.
- This product should not be immersed in fluid.
- Keeler Applanation Tonometers should be serviced and calibrated annually. Any servicing or repairs / modifications should only be carried out by Keeler Ltd. or by suitably trained and authorised distributors. The manufacturer declines any and all responsibility for loss and / or damages resulting from unauthorised repairs; furthermore, any such actions will invalidate the warranty.
- Never use the instrument if the ambient temperature, atmospheric pressure, and/or relative humidity are outside the limits specified in this manual.
- Should the instrument suffer shocks (for example, should it accidentally fall), follow the check procedure outlined in the 'Servicing and Calibrations' (Section 12); if necessary, return the instrument to the manufacturer for repair.
- Use only the listed accessories in conjunction with the instrument; use said accessories only in accordance with the procedures set forth in the instruction manuals.
- Always carefully observe the safety rules and other precautions published herein.
- Do not use in the presence of flammable gases / liquids, or in an oxygen rich environment.
- For indoor use only (protect from moisture).
- Electrical equipment can be affected by electromagnetic interference. If this occurs whilst using this equipment, switch the unit off and reposition.
- If during measurement the slit lamp is moved forward toward the patient or the patient moves toward the slit lamp, the sensor arm will be pushed into contact with a stop spring.

Keeler

4. Cleaning and disinfection instruction

4.1 Cleaning Tonometer body

- Only manual non-immersion cleaning as described below should be used for this instrument.
- Wipe the external surface with a clean absorbent, non-shedding cloth dampened with a water / detergent solution (2% detergent by volume) or water / isopropyl alcohol solution (70% IPA by volume).
- Use caution to ensure the cloth is not saturated with solution.
- Surfaces must be carefully hand-dried using a clean non-shedding cloth.
- Safely dispose of used cleaning materials.

Continued

Keeler

4. Cleaning and disinfection instruction

4.2 Disinfecting the Tonometer prisms

Always disinfect the Tonometer prisms before use. Hand hygiene must be considered to prevent any contamination.

- 1 Carefully remove the Tonometer prism from the prism holder.

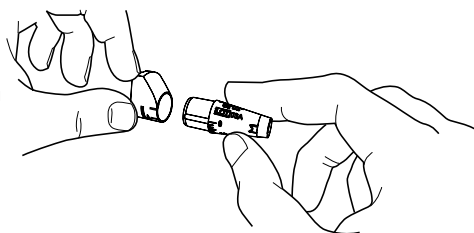

- 2 Wash the Tonometer prism under cold running water for approximately 1 minute, to ensure the Tonometer prism is physically clean before exposed to the disinfection process.

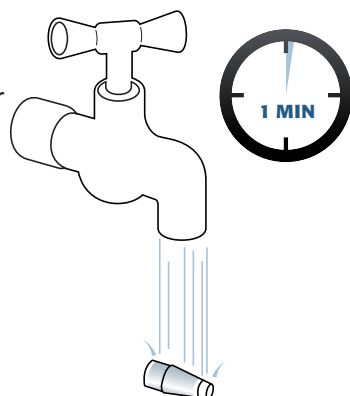

- 3 Immerse the Tonometer prism in the disinfectant fluid. Types of disinfectant fluid vary.

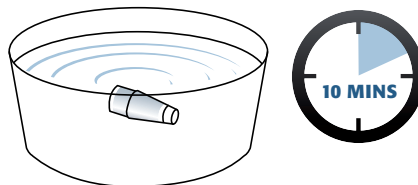

Please follow disinfectant solution guidelines for instructions, concentration and time of immersion. (For example: Pantasept - 3% aqueous solution for 10 minutes, Hydrogen Peroxide 3% aqueous solution for 10 minutes, Sodium Hypochlorite, 10% aqueous solution for 10 minutes etc.).

- 4 Rinse the disinfectant from the prism in running water for between 10 and 30 minutes.

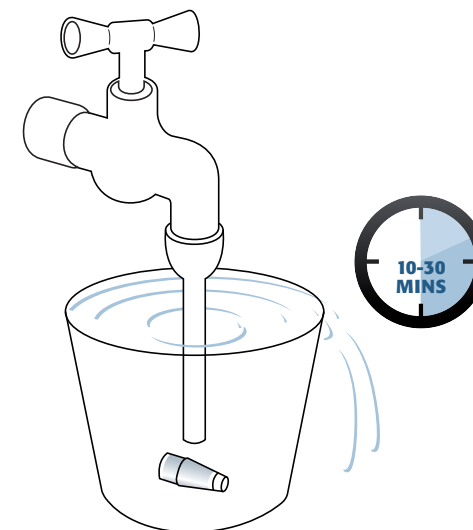

- 5 Dry the disinfected Tonometer prism with a clean soft non shedding cloth.

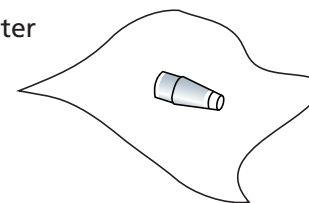

- 6 Store the Tonometer prism in a suitable container ready for use.

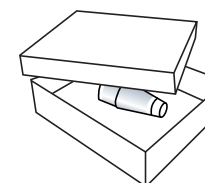

Safely dispose of the disinfectant fluids used.



Do not disinfect using the following:

Alcohol, Acetone, UV radiation, Sterilisation, Immersion in fluid for more than one hour, Temperatures greater than 60°C

5. Tonometer Prism field check



Check the Tonometer prism under the Slit lamp and ensure there are no cracks / chips. the chemical used in the diagnosis process (for example: Fluorescein) will get into the cracks and will show up if observed under the slit lamp. Do not use it if there is any sign of cracks / chips.

6. Name of components

1. Power / function button
2. Main body
3. Rotating measurement drum
4. Doubling prism
5. Measurement arm
6. Manufacturers data
7. Test arm attachment point
8. Battery cover
9. LED display

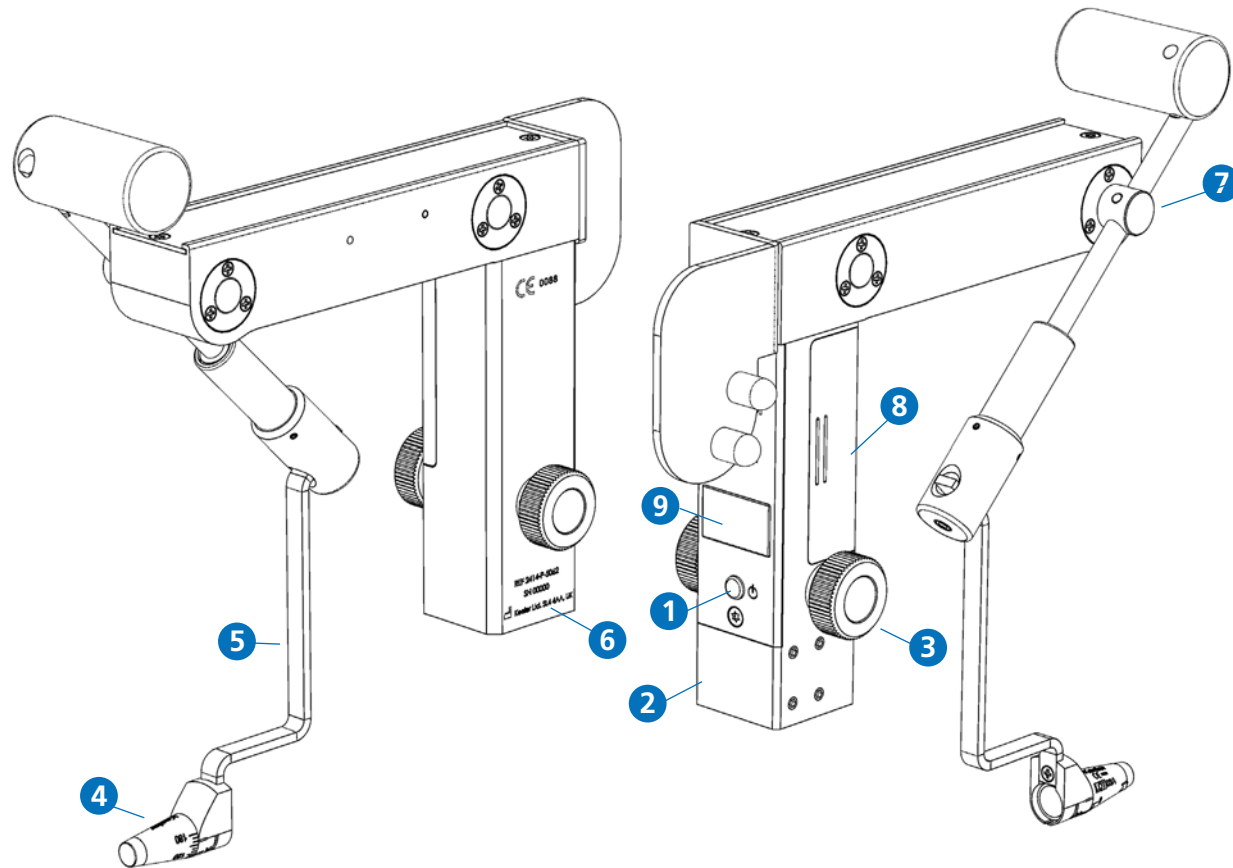

D-KAT Z-type

Part number: 2414-P-2010

7. Switching on / off and configuring the D-KAT

7.1 Switching on / off

To switch the D-KAT on, press the function button briefly and the display will show a nominal reading. The D-KAT can be switched off by pressing the function button again. The unit will power down when not in use after 3 minutes.

7.2 Changing decimal point setting

Turn on the D-KAT and press the function button for more than 3 seconds. The display will flash briefly. Release the function button "dP" (decimal point) or "ndP" (no decimal point) will be displayed. Press the function button briefly to toggle between both. Once the desired display has been set release the function button and the D-KAT will return to the pressure readings display.

7.3 Changing the display brightness

Turn on the D-KAT and press the function button for more than 3 seconds. The display will flash briefly. Release the function button "dP" (decimal point) or "ndP" (no decimal point) will be displayed.

Press the function again for more than 3 seconds, the display will flash and once the function button is released, the display will show "L" together with 0,1,2 or 3. Press the function button briefly to toggle to the desired display brightness.

Note: The D-KAT will return to the main display at any time if the function button is not pressed within the timings listed above.

7.4 Battery status

If "bat" appears in the display when switching on instead of a numerical value, the battery should be replaced immediately. The battery should be replaced using a 1.5v AA Alkaline type.

8. Measurement procedure



8.1 Installation on to the Slit Lamp

Before installing the Tonometer on a Slit Lamp ensure that they are mutually suitable and that the tonometer is level.

- Mount the plate for the Tonometer onto the microscope body using the securing screw.
- Mount the Tonometer onto the mounting post ensuring the grub screws are loose
- Swing the Tonometer arm forward in front of the microscope for examination. Rotate the Tonometer body until the prism is in the center of the view through the eyepiece. Carefully tighten the two retaining grub screws in turn until the Tonometer is secure on the mount and the prism is in the center of view.
- To obtain an image as clear and as free of reflexes as possible, the angle between the illumination and the microscope should be about 60° and the slit diaphragm should be fully opened.
- When not in use the tonometer arm should be swung up against the protection plate.

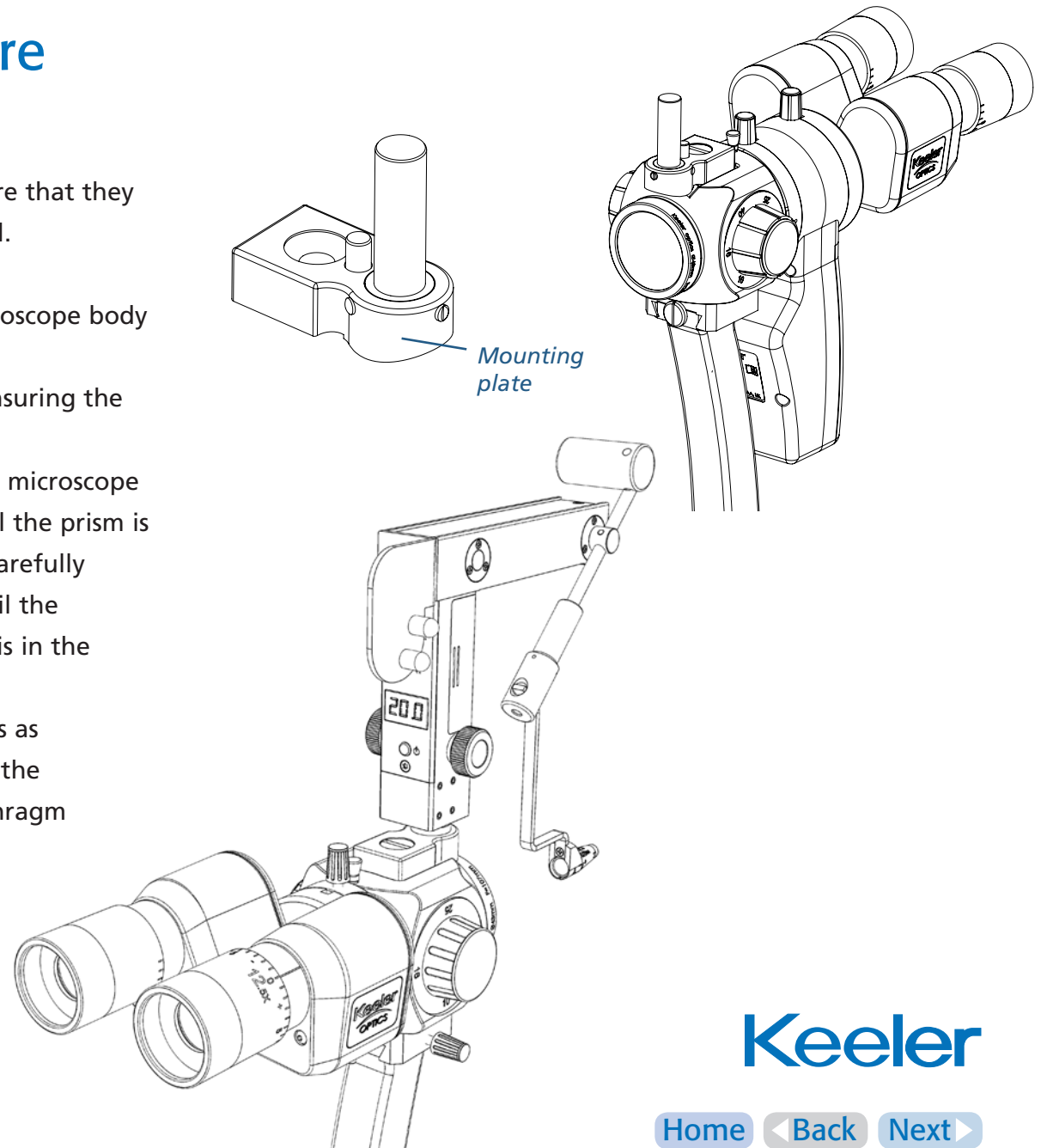

Continued

Keeler

8. Measurement procedure

8.2 Preparing the patient

- Use an appropriate topical anaesthetic to numb the cornea.
- Place a strip of fluorescein-soaked paper near the outer canthus in the lower conjunctival sac. After a few seconds the lacrimal fluid will be coloured and the paper may be removed. When using drops, we recommend a 0.5% solution of fluorescein sodium. If using a 1% or 2% solution, use a glass rod to introduce a small quantity of liquid into the conjunctival sac.
- Seat the patient at the Slit Lamp and place his / her chin on the chinrest and ensure the forehead touches the forehead rest.
- Adjust the chinrest height so that the patients eye is at the correct height (most Slit lamps have a marker on the chinrest pole for correct height adjustment).

 Reusable prisms are not disinfected prior to shipping and must be cleaned before their first use as described in section 4 of this document.

 Check prisms for damage prior to use.

Continued

Keeler

8. Measurement procedure

8.3 Preparing the Slit Lamp instrument for examinations at 10x magnification

- Before beginning measurement, check that the eyepieces of Slit Lamp are correctly focused.
- Set the brightness control of the instrument to a position of a low intensity.
- Set the illumination angle of the Slit Lamp to be approximately 60° to minimise unwanted reflections.
- Insert the blue filter on the slit lamp beam path and fully open the slit diaphragm.



Clean and disinfect prism as described in section 4 of this document.

- Place the doubling prism on into the holder and align the 'zero mark' with the white alignment line on the prism holder, this ensures the mires have a horizontal split.
- Insert the measurement arm so that the measurement head and microscope optics axes are convergent.
- Rotate the measurement drum until 10.0 is displayed on the LED.

Continued

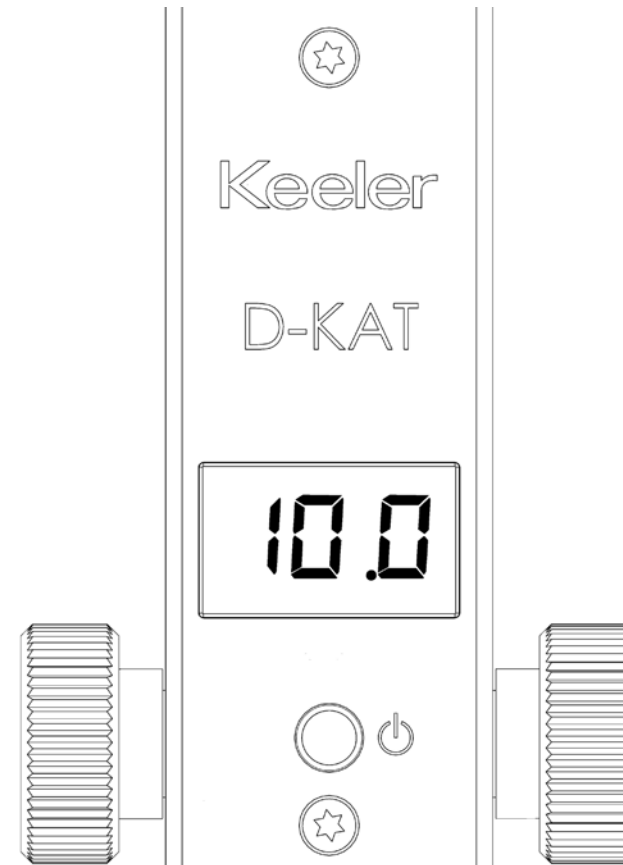

Keeler

8. Measurement procedure

8.4 Using the instrument / taking a measurement

8.4.1 Instructions to the patient

- The patient's head must be firmly positioned on the chin rest and the forehead rest. If necessary, a band may be used to hold the head still.
- Ask the patient to look straight ahead. If necessary, use a fixation target to keep the eyes still.
- We recommend occasionally reminding the patient during the examination, to keep his / her eyes wide open. If necessary, the examiner may use the tips of his fingers to hold the lids open, taking care not to exert pressure on the eye.
- When elevating the lids, the angle between the microscope and the lighting unit must be reduced to about 10° so that the light beam passes through the body of the prism. In this position it should be possible to obtain an image with no reflections.
- Immediately before measurement, ask the patient to close his / her eyes for a few seconds, in order to ensure that the cornea be sufficiently wetted by the lacrimal fluid containing the fluorescein solution.

Continued

Keeler

8. Measurement procedure

8.4.2 Taking the measurement

- Move the Slit Lamp forward to bring the measuring prism into contact with the centre of the cornea in the area above the pupil. The limbus will be illuminated with a bluish light. The examiner will be able to better directly observe this phenomenon from the opposite side.
- As soon as the corneal limbus is correctly illuminated, immediately stop all forward movement of the Slit Lamp.
- After contact is established, observe the cornea through the microscope. When the measurement drum is set to position 10 on the LED, the two semicircular fluorescein rings (which will vary in size according to the ocular pressure) will pulse rhythmically when the Tonometer is in the correct position for measurement.
- Use the Slit Lamp joystick control to make any corrections needed until the applanated surface is observed as two semicircular surfaces of equal area at the Centre of the field of vision. (Figure 1). Small adjustments downward made with the joystick will have no effect on the sizes of the semicircular images.

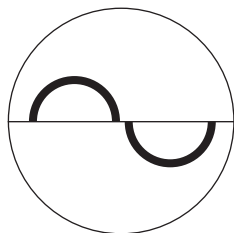

Figure 1: Semicircular images at the Centre of the field of vision.

- Increase the applanation pressure by rotating the Tonometer measurement drum until the margins of the fluorescein rings touch and cross as the eye pulses (Figure 2). The width of the fluorescein rings around the contact position of the measuring prism should be equal to about 1/10 of the diameter of the applanation surface (0,3 mm).
- The LED reading is the ocular pressure expressed in mmHg.

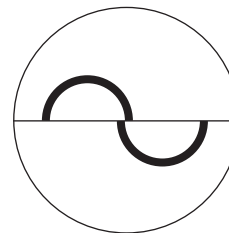
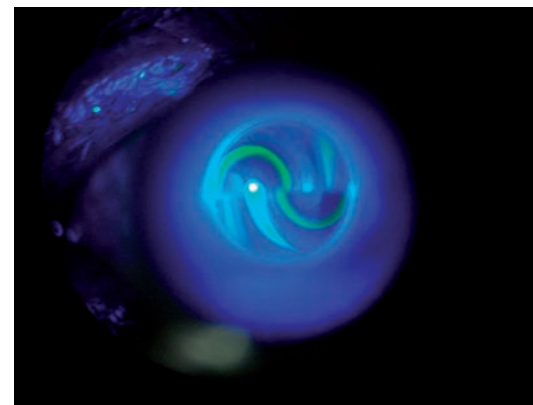

Figure 2: Correct Final Position



Keeler

9. Problem solving

9.1 The fluorescein ring is too wide or too narrow

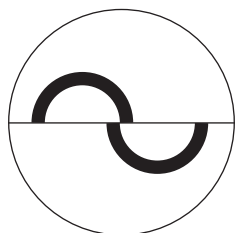

Cause:

The fluorescein semicircles are too wide. The measuring prism was not dried after cleaning, or the eyelids came into contact with the measuring prism during measurement. The pressure reading is higher than the real intraocular pressure.

Correction:

Move the slit lamp back and dry the measuring prism with a wad of sterile cotton wool or lint free cloth.

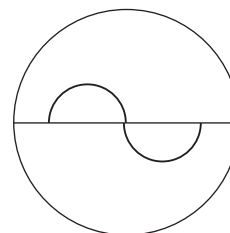

Cause:

The fluorescein semicircles are too narrow. The lacrimal fluid has dried during prolonged measurement. The pressure reading is lower than real ocular pressure.

Correction:

Move the Slit Lamp back and ask the patient to close his / her eyes once or twice, then repeat the measurement procedure.

Continued

Keeler

9. Problem solving

9.2 The measurement prism does not touch the cornea or too much force has been applied

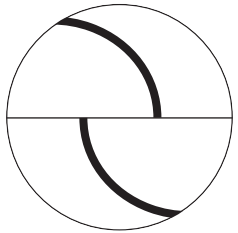

Cause:

If the patient pulls his/her head back even slightly, the pulses will become irregular and the measuring prism contact with the eye will become intermittent. If the patient pulls his / her head even further back, the fluorescein semi-circles will completely disappear.

Correction:

If possible, use a band to hold the patient's head in place.

Cause:

If during measurement the slit lamp is moved forward toward the patient or the patient moves toward the slit lamp, the sensor arm will be pushed into contact with a stop spring and an audible alarm will sound. The applanation surface will be too large. The image will not change when the measurement drum is rotated.

Correction:

Retract the slit lamp until regular pulses and a correspondingly smaller applanation surface are obtained. This is the correct measurement position, in which variations in pressure will not cause immediate variations in the applanation surface.

Continued

Keeler

9. Problem solving

9.3 The two semicircles are not central in the field of vision

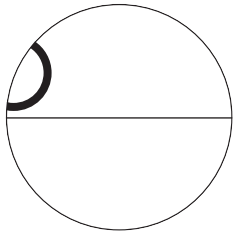

Correction:

Using the joystick, move the slit lamp up and to the left.

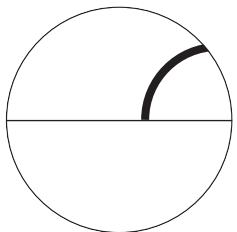
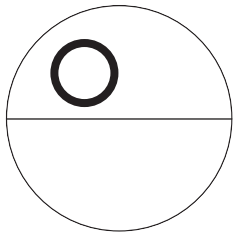

Cause:

The rings are too far to the right.

Correction:

Using the joystick, move the slit lamp to the right.

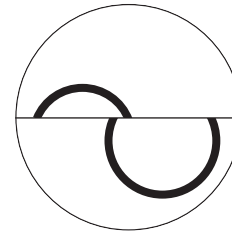

Cause:

The reading in this position is considerably higher than real ocular pressure.

Correction:

Using the slit lamp height adjustment mechanism, lower the slit lamp until the two fluorescein semi circles are equal in size. The measurement pressure will then be reduced.

Continued

Keeler

9. Problem solving

9.4 The inside margins of the fluorescein rings are not aligned and touching

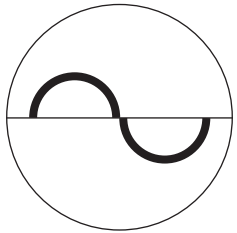

Cause:

The semicircular images are well centred. The outer margins are aligned but the inner margins are not.

Correction:

Increase pressure by rotating the measurement drum.

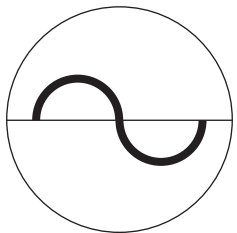

Cause:

In this case, the inner margins of one semicircle are aligned with the outer margins of the other.

Correction:

Increase pressure by rotating the measurement drum.

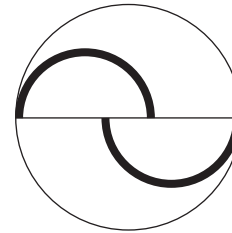

Cause:

Excessive pressure has been applied.

Correction:

Reduce pressure until the semicircular images come closer together and finally the inner margins align with each other, as shown in the last illustration.

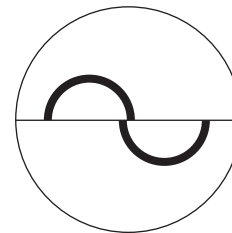

Correct final position

The inner margins of the fluorescein semicircular images are aligned and just touching each other.



10. General information and suggestions concerning measurement

IMPORTANT NOTE

Measurement must be performed as quickly as possible on each eye. Should epithelial drying be observed, we recommend the patients acuity and visual fields should be examined.

The pressure measurement procedure may be repeated several times. Nervous or anxious patients often have higher intraocular pressure during the first measurement procedure.

It has been found that pressure decreases during the first few minutes of the procedure, when the patient realises that the tonometric examination is not unpleasant. When correctly anaesthetised and with their eyes fully open, the patient will feel absolutely nothing. Therefore we recommend running a preliminary measurement procedure on each eye, the results of which need not be taken into consideration. After completing the preliminary procedure, run three measurement procedures on each eye. These readings will be correct if the pressure has stabilised. When the measurement procedures are performed correctly, the results of the subsequent measurements will vary by only about 0,5 mmHg.

When the measurement procedure for one eye is prolonged excessively, a drying phenomena will occur on the corneal epithelium of both eyes.

A ring of fluorescent deposits will form around the cornea contact surface and around the measuring prism on the eye being examined. The other eye will show fluorescent dry areas, resembling a map, which will hinder and make measurement unreliable.

The eye will rapidly recover from any corneal dryness without the need for any treatment, visual acuity may be temporarily affected by fine epithelial defects.

Keeler

11. Astigmatism

If the cornea is spherical, measurements may be made along any meridian, but it is usual to measure along the horizontal 0° meridian. This is not the case when measurements are made on eyes affected by corneal astigmatism of greater than 3 diopters, since the flattened areas will not be circular but elliptical.

It has been calculated that in cases of more severe corneal astigmatism a surface area of 7,354 mm² (∅ 3,06 mm) must be applanated; in this case the measuring prism forms an angle of 43° to the meridian of the maximum radius.

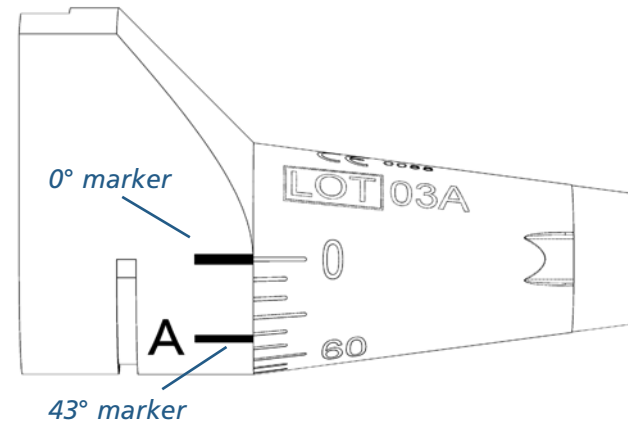

For example:

For corneal astigmatism of 6.5mm / 30° = 52.0 diopters / 30° and 8.5mm / 120° = 40.0 diopters / 120°, the 120° prism value will be aligned with the 43° "A" mark on the prism support.

For corneal astigmatism of 8.5mm / 30° = 40.0 diopters / 30° and 6.5mm / 120° = 52 diopters / 120°, the 30° prism value will be aligned with the 43° "A" mark. In other words, align the axial position of the major radius (that is, the axis of a negative cylinder) with the prism value at the "A" mark on the prism support.

12. Routine instrument maintenance

! Keeler recommends this routine maintenance be carried out by the user frequently to ensure safe and accurate measurement. In the event of the device being outside of the calibration tolerances, it is important to send the device back to Keeler Ltd. or your local dealer for repair and re-calibration.

12.1 Check procedure with test arm set to 20

! This is the most important check procedure, since measurement of intraocular pressure in this area is highly significant. We recommend running this check daily.

This check is made using the test arm (figure 5). The arm is engraved with 5 rings. The centre ring corresponds to 0 mmHg, the immediate left and right rings correspond to 20 mmHg and the outer rings correspond to 60 mmHg.

Slide the bar along the holder until the 20 mmHg reference mark aligns perfectly to the index line on the holder. Ensure that the shorter portion of the test arm faces the examiner.

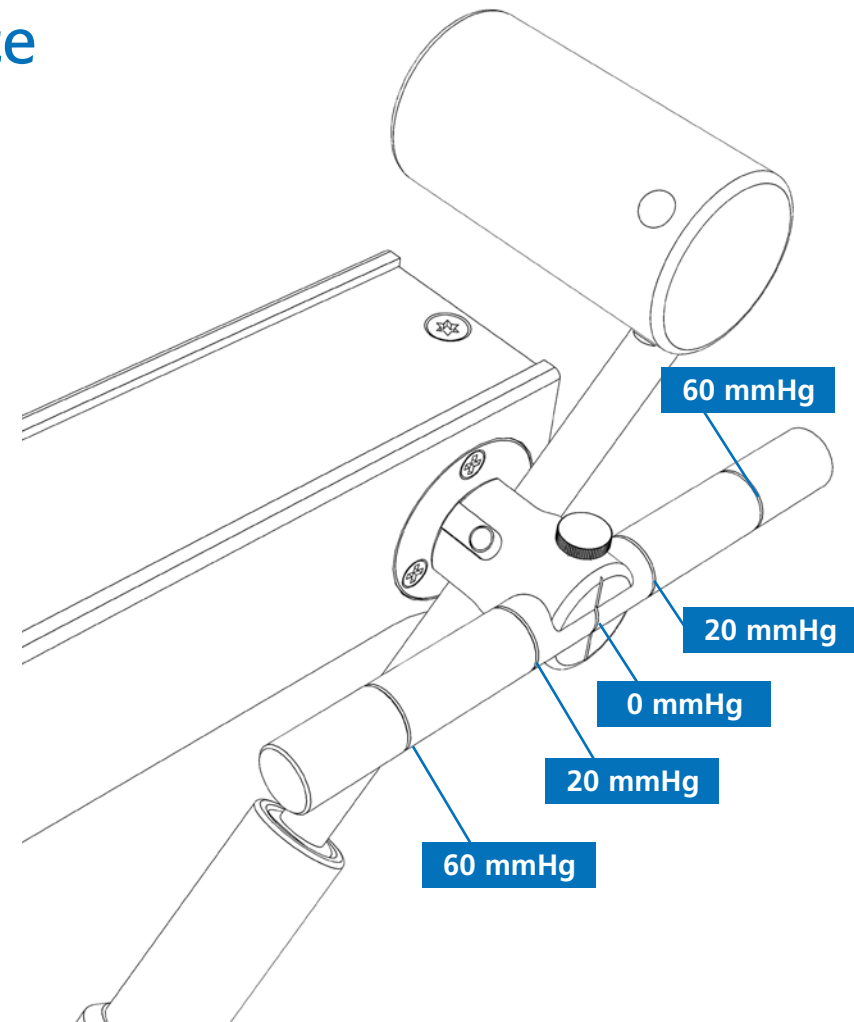

Figure 5: Test arm

Keeler

Continued

12. Routine Instrument Maintenance

12.1 Check procedure with test arm set to 20

Position 19.5

Turn the drum in the direction of the arrow until the LED display reads 19.5.

Then continue to rotate the drum slowly until the measurement arm moves forward. Check to ensure the display reads between 19.5 and 20.5.

Position 20.5

Turn the drum in the direction of the arrow until the LED display reads 20.5.

Then continue to rotate the drum slowly until the measurement arm moves backwards. Check to ensure the display reads between 19.5 and 20.5.

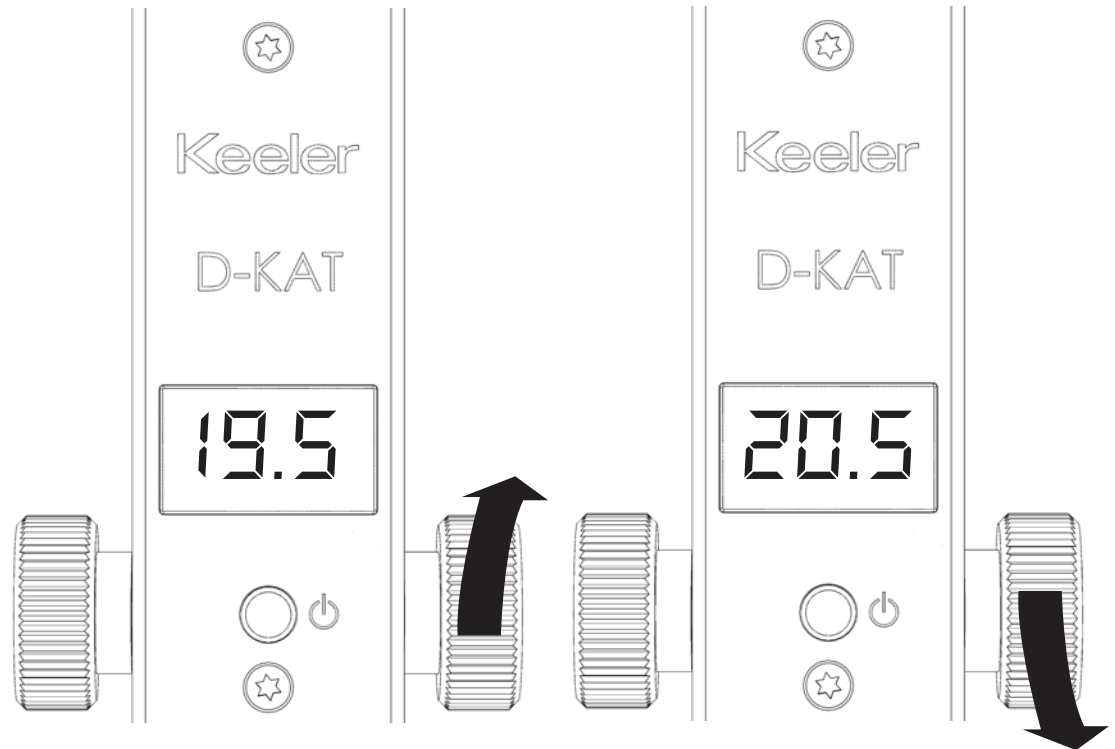

Continued

Keeler

12. Routine Instrument Maintenance

12.2 Check procedure with test arm set to 60

Check 59.0 limit

Turn the drum in the direction of the arrow until the LED display reads 59.0.

Then continue to rotate the drum slowly until the measurement arm moves forward. Check to ensure the display reads between 59.0 and 61.0.

Check 61.0 limit

Turn the drum in the direction of the arrow until the LED display reads 61.0.

Then continue to rotate the drum slowly until the measurement arm moves backwards. Check to ensure the display reads between 59.0 and 61.0.

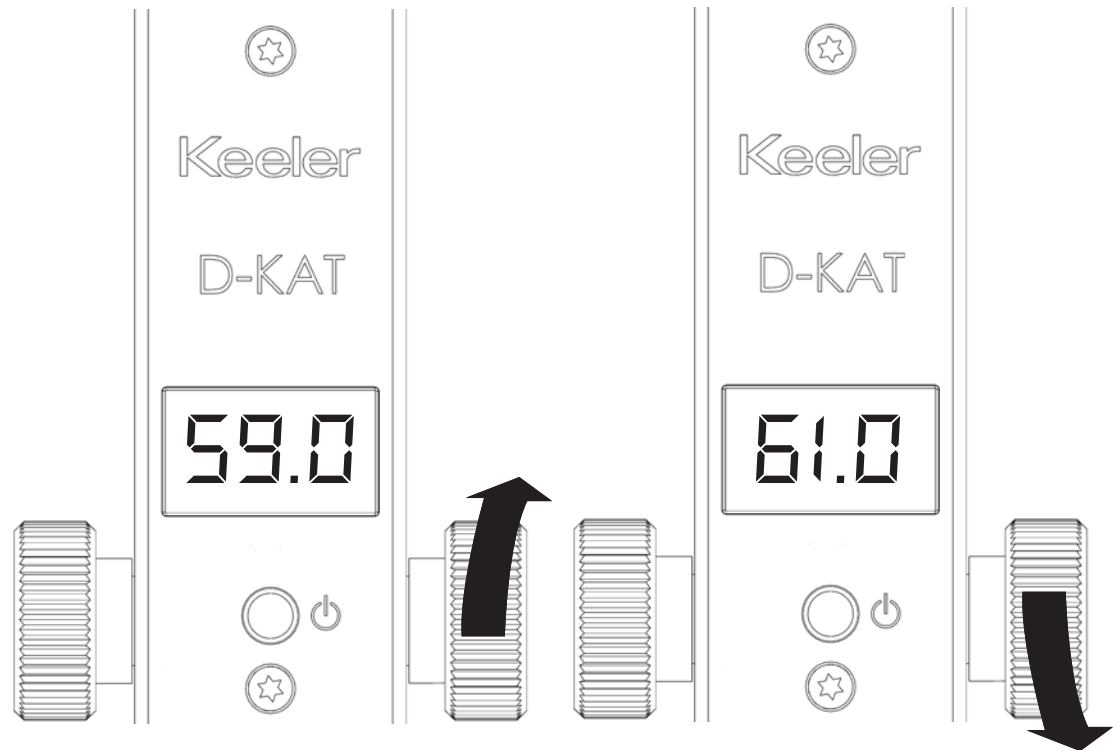

Keeler

13. Servicing and calibration

Keeler recommends annual calibration of the instrument. This must be performed by an authorised service centre or distributor.

There are no user serviceable parts in this instrument. Service manuals will be available to authorised Keeler service centres and Keeler trained service personnel.

13.1 Battery replacement



To replace the battery press in and slide off the battery cover, noting that the positive terminal of the battery is at the top.



The correct battery to use is 1.5v AA ALKALINE TYPE.



Remove the battery if the unit is to be stored for a period of 2 months or over.

14. Specifications

14.1 Transport, storage and working conditions

The following ambient condition limits are recommended for the Keeler Applanation Tonometer, for transport and storage it is recommended that the Tonometer is kept in its original manufacturers packaging.

Before use the Tonometer should be allowed to adjust to the ambient room temperature for several hours.

Ambient Conditions

Transportation	Temperature	-40°C to +70°C
	Air Pressure	500 hPa to 1060 hPa
	Relative humidity	10% to 95%
Storage	Temperature	-10°C to +55°C
	Air Pressure	700 hPa to 1060 hPa
	Relative humidity	10% to 95%
Use	Temperature	+10°C to +35°C
	Air Pressure	800 hPa to 1060 hPa
	Relative humidity	30% to 75%

14. Specifications

14.2 Technical specifications

Installation:	
Keeler digital Z-type: for Zeiss type illumination systems	Mountable on post on microscope
Installation	Assembled on the guide plate on the slit lamp
Measurement range	5 - 65 mmHg (0.66 - 8.65kPa)
Measurement deviation	0.49 mN or 1.5% of measurement value, whichever is the greater
Operating temperature range	From 10°C to 35°C
Reverse span (Hysteresis)	≤ 0.49 mN
Net weight	
Keeler digital Z-type	0.6 kg (without accessories)
Part Numbers	
Keeler digital Z-type	2414-P-2010

15. Accessories and warranty

15.1 Accessories

Tonometer doubling prism	Part Number 2414-P-5001
Test arm assembly	Part Number 2414-P-5045
Z-type post (R)	Part Number 2414-P-5038
Battery	Part Number 1909-P-7129

15.2 Product warranty

2 years against faulty workmanship, materials and labour.

Warranty will be conditional on routine maintenance and will not cover calibration or mechanical issues caused as a result of lack of maintenance, poor use, incorrect transport or inappropriate storage conditions.



Tonometer doubling prism



Test arm assembly



Z-type post (R)

16. Contact, packaging and disposal information

Manufacturer

Keeler Limited
Clewer Hill Road
Windsor
Berkshire
SL4 4AA

Freephone 0800 521251
Tel +44 (0) 1753 857177
Fax +44 (0) 1753 827145

USA Sales Office

Keeler USA
456 Parkway
Broomall
PA 19008
USA

Toll Free 1 800 523 5620
Tel 1 610 353 4350
Fax 1 610 353 7814

India Office

Keeler India
Halmer India Pvt. Ltd.
B1-401, Boomerang, Chandivali
Andheri (East) Mumbai - 400072
India

Tel +91 (22) 6708 0405
Fax +91 (99303) 11090

China Office

Keeler China
1012B
KunTai International Mansion
12B ChaoWai St.
Chao Yang District
Beijing, 10020
China

Tel +86 (10) 51261868
Fax +86 (10) 58790155

Disposal of old electrical and electrical equipment

(Applicable in the European Union and other European Countries with separate Collection Systems).



This symbol on the Product or on its Packaging and instructions indicates it was put on the market place after August 2005 and this product shall not be treated as Household Waste.

To reduce the environmental impact of WEEE (Waste Electrical Electronic Equipment) and minimise the volume of WEEE entering landfills we encourage at product end of life that this Equipment is recycled and reused.

If you need more information on the collection, reuse and recycling then please contact B2B compliance on 01691 676124 (+44 1691 676124). (UK only).

EP59-70036 Issue 3

Keeler